



CATALOGUE 05 | 26

ZKONG PROFILES

ONE STOP SHOP

OWN TOOL
CONSTRUCTION

ISO 9001:2015

CUSTOMIZED
SERVICES

CONTENT



CATALOGUE 05 | 26

ZKONG

3—7

ACCESSORIES

8



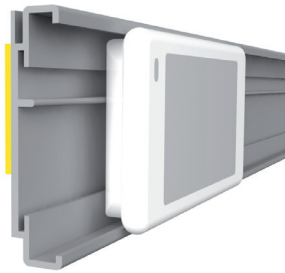

ESL ZKONG

ESL flat profile with adhesive tape

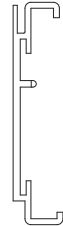

profile name	art.no
ESL ZKONG	GG001

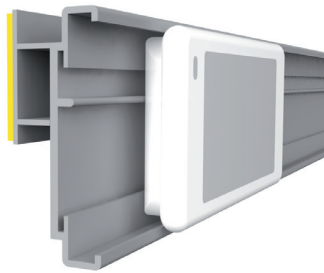

ESL G ZKONG

ESL profile with adhesive tape and soft hinge, compatible with our angular adapter EI264 for adjustable inclination

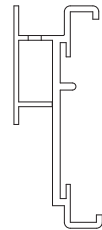

profile name	art.no
ESL G ZKONG	GG005

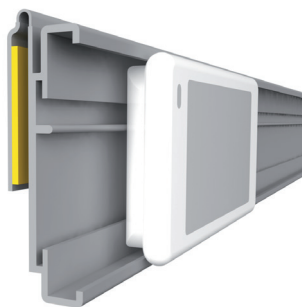

ESL FG ZKONG

ESL profile with adhesive tape and soft hinge



profile name	art.no
ESL FG ZKONG	GG023

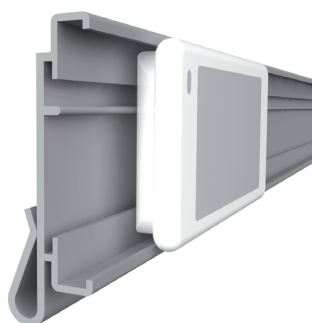

ESL CLIP ZKONG

Universal clip to use with existing data strips for paper labels

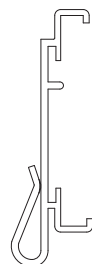

profile name	art.no
ESL CLIP ZKONG	GG004

ZKONG

HOLDERS FOR ELECTRONIC SHELF LABELS

HOLDERS

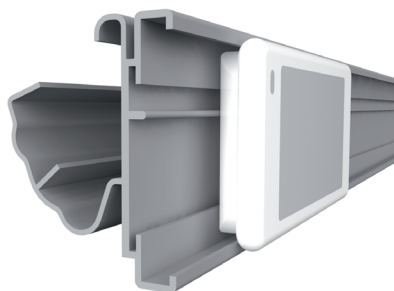

ESL LST_2 ZKONG

ESL profile for LINDE, STOREBEST and TEGOMETALL shelves

profile name

art.no

ESL LST_2 ZKONG

GG008

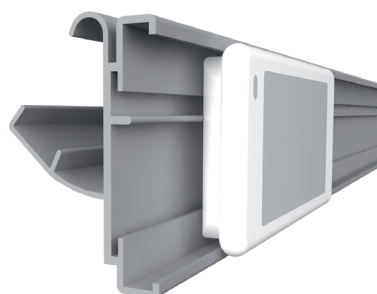
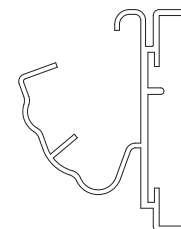

ESL MOEX ZKONG

ESL profile for MODERN EXPO shelves

profile name

art.no

ESL MOEX ZKONG

GG003

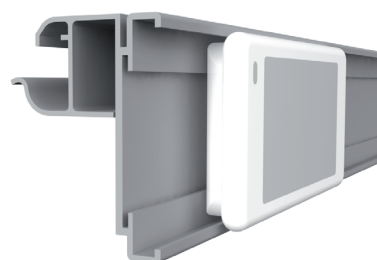
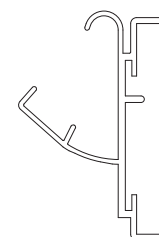

ESL WWTG ZKONG

ESL profile for WANZL (Wire-Tech) shelves with soft hinge, compatible with our angular adapter EI264 for adjustable inclination

profile name

art.no

ESL WWTG ZKONG

GG014

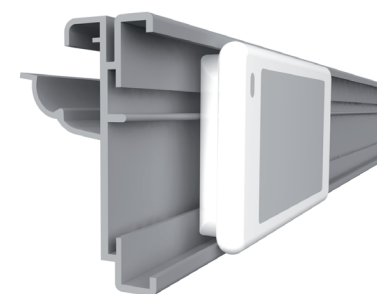
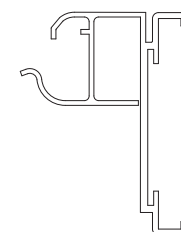

ESL FRW ZKONG

ESL profile for WANZL (Wire-Tech) shelves

profile name

art.no

ESL FRW ZKONG

GG024

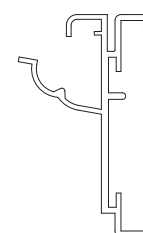

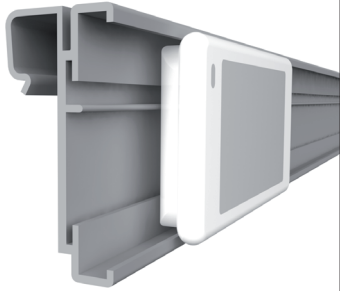

ESL KET ZKONG

ESL profile for wire shelves

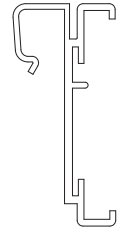

profile name	art.no
ESL KET ZKONG	GG012

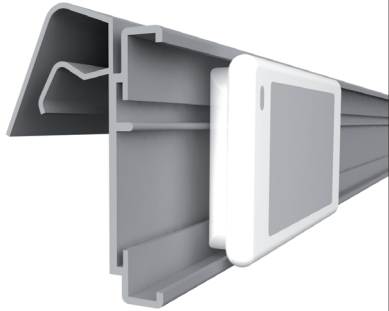

ESL KE ZKONG

ESL profile for wire shelves

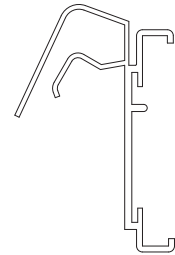

profile name	art.no
ESL KE ZKONG	GG010



ESL DRA ZKONG

ESL profile for wire hooks

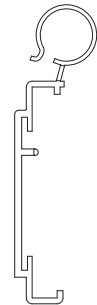

profile name	art.no
ESL DRA ZKONG	GG002 short

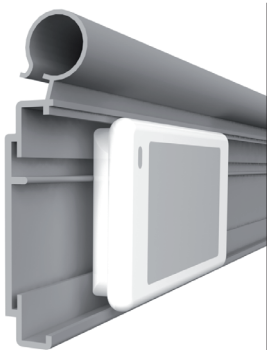

ESL DRA ZKONG

ESL profile for wire shelves

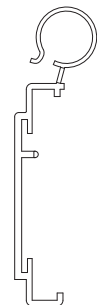

profile name	art.no
ESL DRA ZKONG	GG002 long

ZKONG

HOLDERS FOR ELECTRONIC SHELF LABELS

HOLDERS

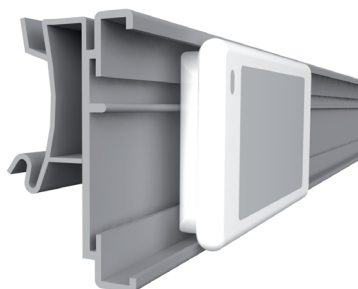

ESL HSA ZKONG

ESL profile for HERMES, LAFORTEZZA and YUDIGAR shelves with soft hinge, compatible with our angular adapter EI264 for adjustable inclination

profile name

art.no

ESL HSA ZKONG

GG006

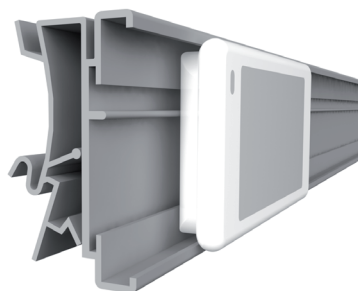
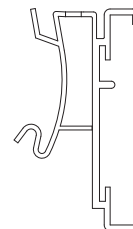

ESL HSA_2 ZKONG

ESL profile for HERMES, LAFORTEZZA and YUDIGAR shelves with soft hinge and adjustable angle position

profile name

art.no

ESL HSA_2 ZKONG

GG007

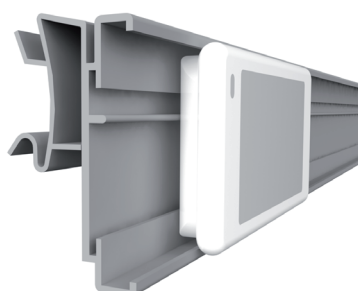
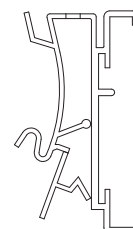

ESL IMZ ZKONG

ESL profile for INTRAC and ARNEG shelves with soft hinge, compatible with our angular adapter EI264 for adjustable inclination

profile name

art.no

ESL IMZ ZKONG

GG013

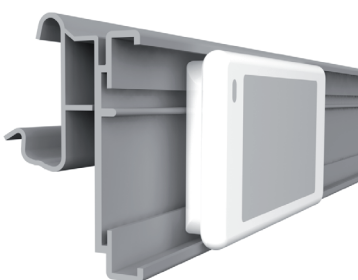
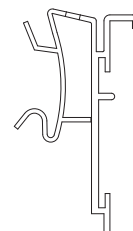

ESL CEFLA ZKONG

ESL profile for CEFLA shelves with soft hinge, compatible with our angular adapter EI264 for adjustable inclination

profile name

art.no

ESL CEFLA ZKONG

GG009

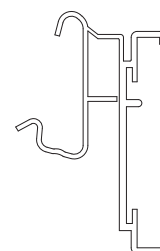

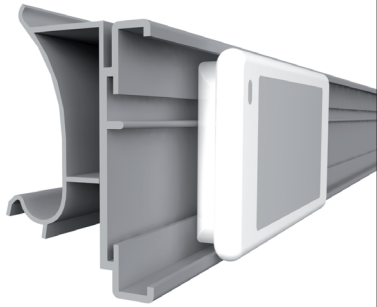

ESL SIDAC ZKONG

ESL profile for SIDAC shelves with soft hinge, compatible with our angular adapter EI264 for adjustable inclination

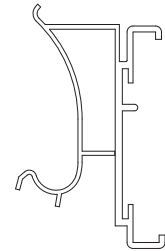

profile name	art.no
ESL SIDAC ZKONG	GG011

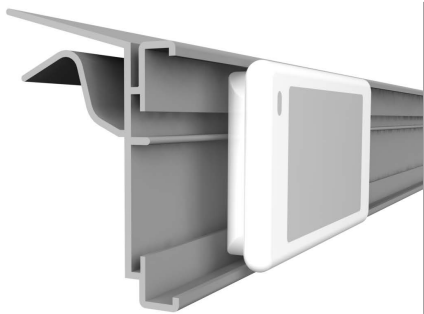

ESL GLS ZKONG

ESL profile for glass shelves

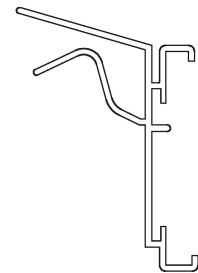

profile name	art.no
ESL GLS ZKONG	GG027

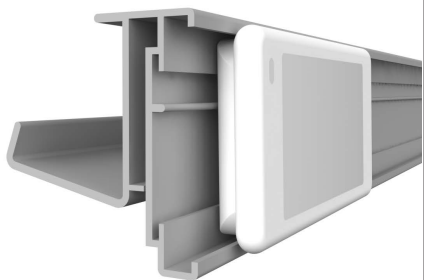

ESL ARC ZKONG

ESL profile for ARCON shelves with soft hinge, compatible with our angular adapter EI264 for adjustable inclination

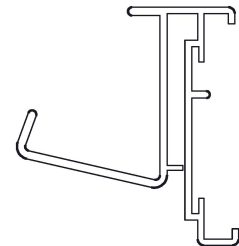

profile name	art.no
ESL ARC ZKONG	GG028

ACCESSORIES

ACCESSORIES

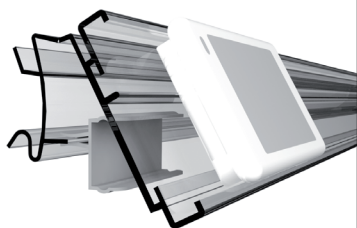

Angular adapter

The Angular adapter EI264 is designed to be used in two different positions. It can only be used on the rails specified within this catalogue



profile name	art.no
Angular adapter	EI264



Cover for ESL ZKONG

Cover for ESL ZKONG profiles; except GG002, GG004, GG005



profile name	art.no
Cover for ESL ZKONG	SN018

40 YEARS OF EXPERIENCE



INDEPENDENCE

our equipment and processes are fully self-contained within our production facilities

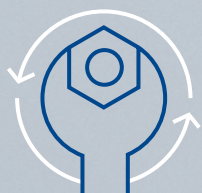

FULL TURN-KEY SERVICE

from the initial consultation, design to the finished product



QUALITY

our products meet the international ISO 9001:2015 standard

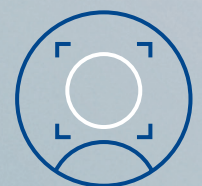

CUSTOMER ORIENTED

management & technical team

Extruindustrie CR s.r.o.

Průmyslová 505
Ždírec nad Doubravou
582 63
Czech Republic



T: +420 569 695 002
E: INFO@EXTRUINDUSTRIE.CZ
W: EXTRUINDUSTRIE.CZ